

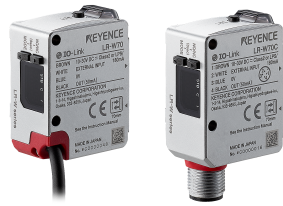

## Full-Spectrum Sensor LR-W70(C) Instruction Manual



Read this manual before using the product in order to achieve maximum performance. Keep this manual in a safe place after reading it for future reference.

The following symbols alert you to important messages. Be sure to read this section carefully.

	Indicates a hazardous situation which, if not avoided, could result in death or serious injury.
	Indicates a situation which, if not avoided, could result in product damage as well as property damage.

## 1. Introduction

### 1-1 Safety Precautions

	<ul style="list-style-type: none"> <li>This product is only intended to detect object(s). Do not use this product for the purpose of protecting a human body or a part of the human body.</li> <li>This product is not intended for use as an explosion-proof product. Do not use this product in a hazardous location and/or potentially explosive atmosphere.</li> <li>This product uses DC power. The product may explode or burn if an AC voltage is applied.</li> </ul>
	<ul style="list-style-type: none"> <li>Do not wire this product along with power lines or high-tension lines. Doing so may lead to product malfunctions or damage due to noise.</li> <li>Do not use this product outdoors or in a place where extraneous light can enter the light-receiving element directly.</li> </ul>

### 1-2 Precautions on Regulations and Standards

#### ■ CSA Certificate

This product complies with the following CSA and UL standards and has been certified by CSA. Be sure to consider the following specifications when using this product as a CSA-certified product.

- Applicable standards: CAN/CSA C22.2 No. 61010-1, UL61010-1

- Use one of the following types of power supplies.

A CSA/UL certified power supply that provides Class 2 output as defined in the CEC (Canadian Electrical Code) and NEC (National Electrical Code) or a CSA/UL certified power supply that has been evaluated as a Limited Power Source as defined in CAN/CSA-C22.2 No. 60950-1/UL60950-1.

- Use this product at an altitude of 2000 m or less.
- Overvoltage category: I
- Pollution degree: 3
- Indoor use only.

#### ■ CE Marking

KEYENCE Corporation has confirmed, on the basis of the following specifications, that this product complies with the essential requirements of the applicable EU Directive. Be sure to consider the following specifications when using this product in a member state of the European Union.

#### ● EMC Directive

- Applicable standard: EN60947-5-2, Class A

These specifications do not give any guarantee that the end-product with this product incorporated complies with the essential requirements of the EMC Directive. The manufacturer of the end-product is solely responsible for confirming the compliance of the end-product itself according to the EMC Directive.

#### ● Low-voltage directive

- Applicable standard: EN62471

## 1-3 Package Contents

- Sensor
- Instruction manual

## 1-4 Specifications

Model	LR-W70		LR-W70C	
	2 m cable type		4-pin M12 connector type	
Detectable distance	30 to 70 mm			
Min. spot size	Approx. 1.6x2.9 mm at 50 mm			
Response time <sup>*1*</sup>	200 μs / 1 ms / 10 ms / 100 ms / 500 ms selectable			
Light source	White LED			
Mutual interference reduction function	Up to 2 units with alternate frequencies set			
Timer function	OFF/ON delay/OFF delay/One-shot			
Power supply	Power supply voltage	10 to 30 VDC, including 10% ripple (P-P), Class 2 or LPS		
	Current consumption <sup>*4</sup>	60 mA or less at 24 V (without load), 110 mA or less at 12 V (without load)		
I/O <sup>*5</sup>	Control output	NPN open collector/PNP open collector selectable, 30 V or less, 50 mA or less, residual voltage: 2 V or less, N.O./N.C. selectable		
	External input	Tuning /Transmission OFF selectable, Short-circuit current: NPN: 1 mA or less, PNP: 2 mA or less, For the applied voltage, see the wiring diagrams (□□ page 2 in the instruction manual), For the input times, see the time charts (□□ page 7 in the instruction manual)		
Protection circuit	Protection against reverse power connection, power supply surge, output overcurrent, output surge, and reverse output connection			
Environmental resistance	Enclosure ratings	IP65/IP67 (IEC60529)		
	Ambient light	Incandescent lamp: 10000 lux or less Sunlight: 20000 lux or less		
	Ambient temperature	-20 to +50°C (no freezing)		
	Ambient humidity	35 to 85%RH (no condensation)		
	Shock resistance	1,000 m/s <sup>2</sup> in X, Y, Z axis directions respectively 6 times		
Vibration resistance	10 to 55 Hz Double amplitude 1.5 mm in the X, Y, Z axis directions respectively, 2 hours			
Material	Case: Zinc die cast (Nickel chrome plating) Indicator cover: PPSU Buttons: PES Lens cover and display: PMMA (scratch-resistant coating) Cable bushing (2 m cable type only): PBT Cable (2 m cable type only): PVC Connector ring (4-pin M12 connector type only): PMP Connector socket (4-pin M12 connector type only): PEI			
Weight	Approx. 130 g (including cable)		Approx. 75 g	

\*1 When you set an alternate frequency, the response time becomes approximately 20% slower.

\*2 500 μs / 2.5 ms / 20 ms / 200 ms / 999 ms (when using Difference Monitoring)

\*3 400 μs / 2 ms / 20 ms / 200 ms / 999 ms (when using 2-Point Matching)

\*4 180 mA or less (at 10 V, with load)

\*5 IO-Link specification v.1.1/COM2 (38.4 kbps) is supported.

You can download a setup file from the KEYENCE website (<http://www.keyence.com>). If you are using the product in an environment in which you cannot download files over the Internet, contact your nearest KEYENCE office.

## 1-5 Part Functions

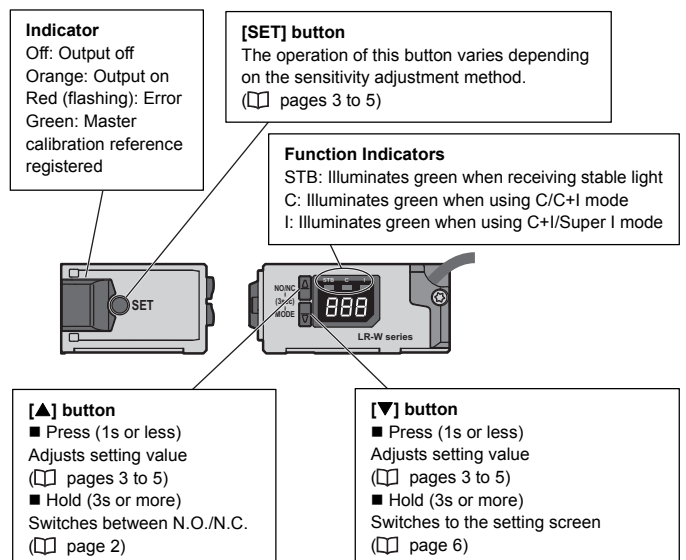

## 2. Installation and Wiring

### 2-1 Installation

- Tightening torque for the mounting holes: 0.63 N·m (M3 screw)
- If the workpiece contains a glossy surface that could interfere with stable detection, tilt the sensor approx. 15° to 20°. If tilting the sensor does not improve detection, please attach the reflection canceling attachment (LR-WA2).

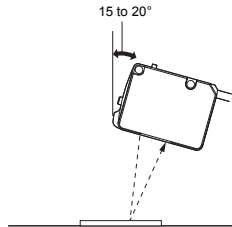

- High-frequency light, such as that from an inverter fluorescent lamp, entering the receiver directly or after reflecting from the workpiece may lead to malfunctions. In this situation, implement countermeasures such as installing a light shielding plate or changing the product's installation position.

### 2-2 Wiring

Either an NPN or a PNP output can be selected during the initial setup of this product.

☞ "3. Initial Settings (NPN/PNP Selection)" (page 2)

Independently insulate any unused I/O wires.

 = Load (input device)

#### • When NPN output is selected

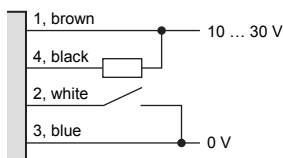

#### • When PNP output is selected

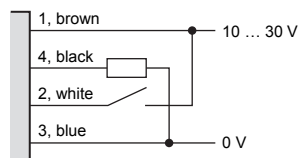

## 3. Initial Settings (NPN/PNP Selection)

When the power is turned on for the first time after purchase, or initialization is performed, the initial setting (NPN/PNP selection) is required as shown below.

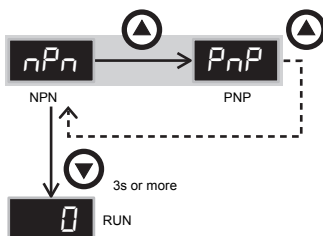

- \* After the initial setup is complete, "NPN/PNP selection" setting cannot be changed. To change this setting, initialize the sensor. ☞ "7-2 Initialization" (page 5)

## 4. Basic Settings

### 4-1 Output Logic Selection (N.O./N.C. Selection)

Set the output logic to N.O. or N.C..

- $n_o$  (LON)\*: Turns the output on when the registered condition is met (turns the output on when light is received)\*.
- $n_c$  (don)\*: Turns the output on when a condition other than the registered condition is met (turns the output on when light is not received)\*.

\* The condition within parentheses indicates the condition when super I mode is selected.

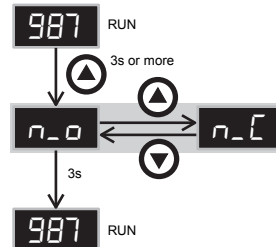

### 4-2 Detection Mode

This sensor contains four detection modes.

Detection mode	Explanation
Auto (default)	When adjusting the sensitivity, the optimal mode is automatically selected between C+I or C.
C+I mode	Detection is performed according to the color components (R, G, B) and illumination (the received light intensity).
C mode	Detection is performed according to the color components (R, G, B) only.
Super I mode	Detection is performed according to the illumination (the received light intensity) only.

\* To change the detection mode, see ☞ "8 Settings" (page 6).

### 4-3 Spot/Mode Selection

This product is equipped with a [2-Spot Mode], which utilizes 2 spots for detection.

When using the [2-Spot Mode], select one of the detection methods below. Note that the sensor operates in [C+I mode] when in [2-Spot Mode].

Spot	Description	
1-Spot Mode (default)	Detection based off of 1 spot. Utilized for standard target detection.	
2-Spot Mode	Difference Monitoring	Detection based on the difference in appearance between the 2 spots. Typical tuning operation is not required.
	2-Point Matching	Detects based on the degree of conformity of both spots to a calibrated reference.

\* For details on calibration in [2-Spot Mode], ☞ refer to "6. Sensitivity Adjustment (2-Spot Mode)" (page 5).

## 5. Sensitivity Adjustment (1-Spot Mode)

### 5-1 Auto/C+I/C Mode

#### ■ About the display value

- Conformity

The level of conformity of the current detected workpiece to the registered reference workpiece.

Display range: 0 to 999 (The more the workpiece conform to reference workpiece, the higher the value.)

- Setting value

The threshold of conformity at which a workpiece is judged to be the same as the registered workpiece.

To check or manually make fine adjustments to the setting value, see □ "■ Checking and adjusting the setting value" (page 3).

\* The blinking numeric value that appears after calibration is the setting value.

#### ■ Setting the sensitivity (apply one of the following three methods)

##### ● 1-point calibration (use to detect 1 specific color)

Register the color of the workpiece to be detected.

(When Auto mode is used, this function operates in C+I.)

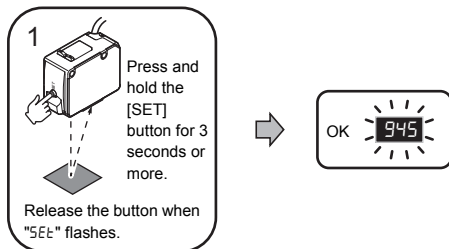

##### ● 2-point calibration (use to differentiate between 2 colors)

Register the color of the reference workpiece and the color to be differentiated. (The first point is used as the reference color.)

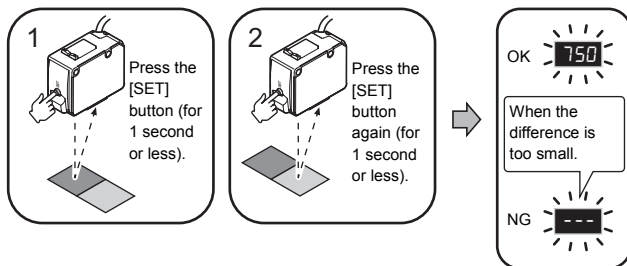

##### ● Master calibration (use to permit color variations within the same workpiece)

Press the [SET] button to register the reference color. Then, press and hold the [SET] button to perform sampling. During sampling, references are added and are set to be judged as the same color. When a reference is added, the indicator flashes (once) in green.

When master calibration is executed, the setting value becomes 950 (default). To change this value, see □ "8-9 Master Calibration Set Value" (page 7).

(When Auto mode is used, this function operates in C+I.)

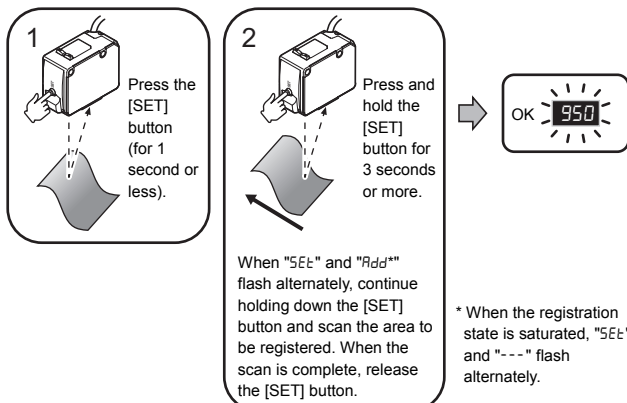

< Precautions for master calibration >

- Continue calibration until the green light that indicates reference addition does not turn on any more.
- If the master calibration is performed again, the registered contents from the first master calibration will be overwritten. To add an allowable range after the master calibration, perform the master addition calibration.
- If the registration status is saturated and "----" is displayed. Perform the master calibration again after lowering the □ "8-9 Master Calibration Set Value" (page 7).
- Changing the master calibration set value after a master calibration has been performed, does not affect the current setting value, only subsequent calibrations.

#### ■ Permitting color variations between different workpieces

##### ● Master addition calibration (when adding workpieces to be permitted)

Position a workpiece which is to be judged the same as the current registered color. Then press and hold the [SET] button and the [▼] button. When the added registration is successful, the "setting value" flashes three times, and the sensor returns to the normal screen (the setting value is not changed at this point in time).

In this case, references are added to permit colors between "the current registered color" and "the additional registered color".

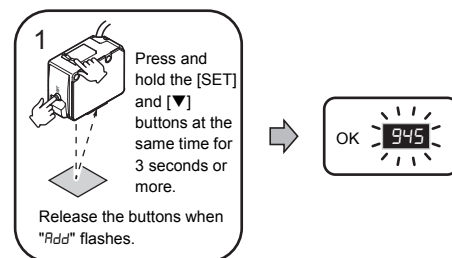

< Precautions for master addition calibration >

- To clear the master addition calibration, perform another calibration.
- If the setting fails or the registration state is saturated, "----" is displayed. To add an allowable range, lower the setting value, and perform the master addition calibration again.

#### ■ Checking and adjusting the setting value

When a larger setting value is in place, the detection tolerance is tight.

In contrast, when the setting value is reduced, a wider detection tolerance is enabled. The [▲] and [▼] buttons can be used to increase or decrease the setting value.

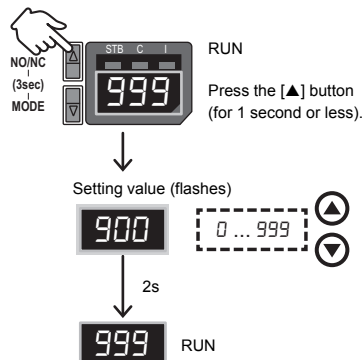

\* After master calibration or master addition calibration has been executed, the setting value cannot be increased.

#### ■ When the received light intensity is saturated or insufficient

When using the product with the [h5P (200 μs)] or [1 ms] response time, "----" or "----" may be displayed if the light intensity is saturated or insufficient, respectively. In this case, it is beneficial to recalibrate the sensor, since the light intensity is automatically adjusted during calibration.

## 5-2 Super I Mode

### ■ About the display value

- Received light intensity

The current received light intensity is displayed.

Display range: 0 to 999 (The greater the received light intensity, the higher the value.)

- Setting value

The threshold at which the received light intensity is judged to indicate that a workpiece is present.

To check or manually make fine adjustments to the value, see □ "■ Checking and adjusting the setting value" (page 4).

\* The blinking numeric value that appears after calibration is the setting value.

### ■ Setting the sensitivity (apply one of the following three methods)

#### ● 2-point calibration (basic intensity differentiation)

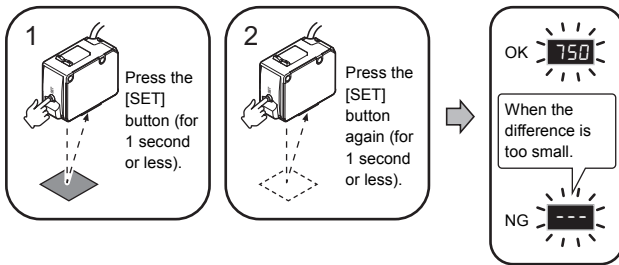

#### ● Maximum sensitivity calibration (use to increase the sensitivity of the sensor to detect small changes)

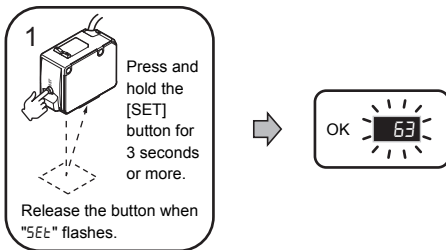

#### ● Full auto calibration (use when workpiece movement cannot be stopped for calibration)

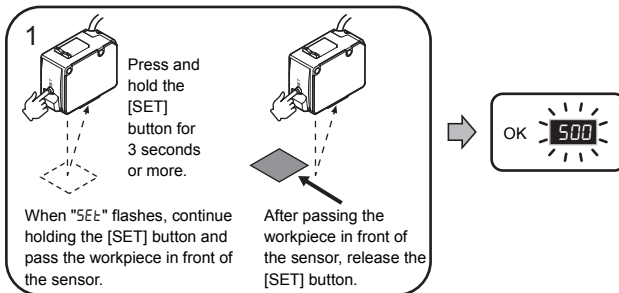

### ■ Checking and adjusting the setting value

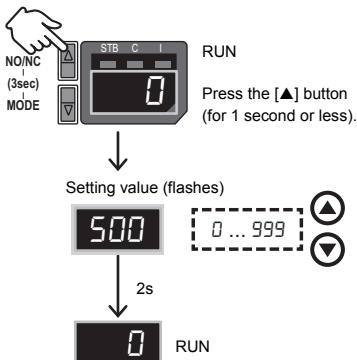

### ■ When the received light intensity is saturated or insufficient

When using the product with the [h5P (200 μs)] or [1 ms] response time selected, stable operation may be reduced. In this situation, it may be possible to increase stability by adjusting the light intensity to the optimal value using the steps below.

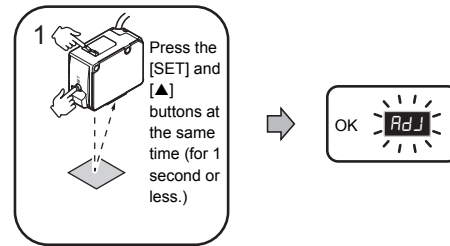

## 6. Sensitivity Adjustment (2-Spot Mode)

### 6-1 Difference Monitoring

- Detect appearance variations in parts without calibration (ideal for mark detection).

By monitoring the difference in appearance between the 2-spots, the sensor is able to stably detect variations in a target's appearance without the need for calibration.

For example, if the appearances of the two spots are identical, then they would have the same degree of conformity of [999] and the display value would be [0]. The display value will increase as the difference between the two spots increases.

<Operation example>

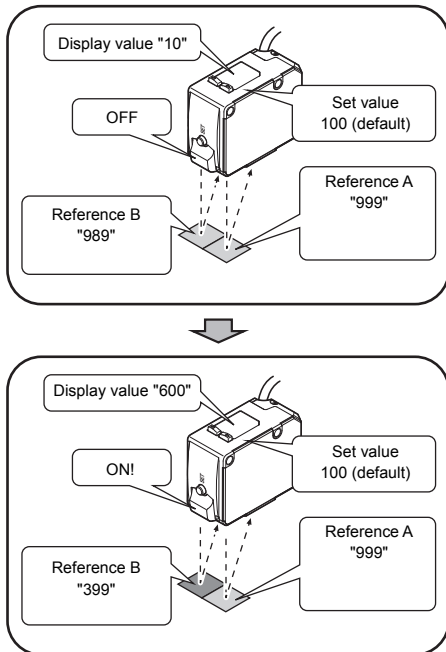

\* When confirming the set value or making fine adjustments manually, refer to "■ Checking and adjusting the setting value" (page 3). For Difference Monitoring, the larger the set value, the larger the difference required for detection, and the smaller the set value, the more sensitive the sensor is to differences.

### 6-2 2-Point Matching

#### ■ Setting the sensitivity

- Detects when the degrees of conformity of both spots are the same or greater than the set value\*1.

Calibrate a specific reference appearance using the method below \*2.

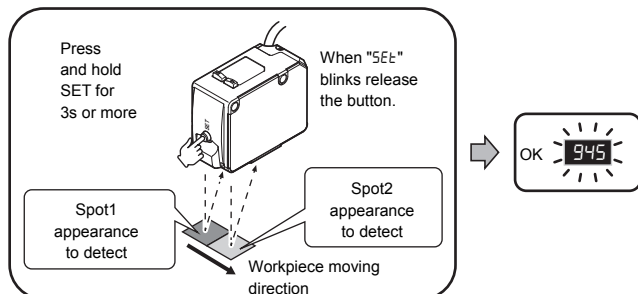

\*1 When confirming the set value or making fine adjustments manually, refer to "■ Checking and adjusting the setting value" (page 3).

\*2 When using the product with the [H5P (400 μs)] or [2 ms] response time, "----" or "..." may be displayed if the light intensity is saturated or insufficient, respectively. In this case, it is beneficial to recalibrate the sensor, since the light intensity is automatically adjusted during calibration.

<Operation example>

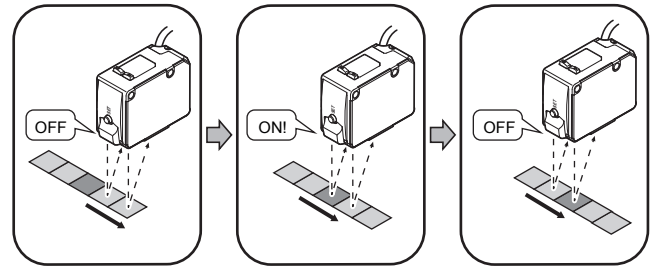

## 7. Useful Functions

### 7-1 Key Lock

This function prevents operation mistakes, or the inadvertent changing of settings, by locking/disabling key operations. To require a password to release the key lock, set a password in advance. "8-10 Password" (page 7)

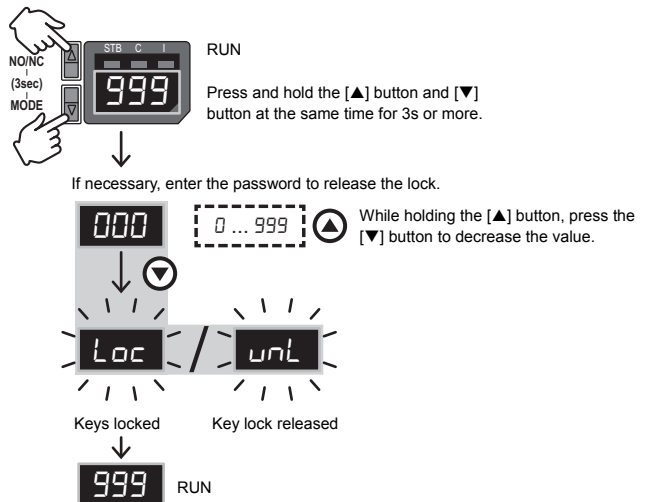

### 7-2 Initialization

It is possible to reset the product to its factory default settings. After initialization, the user must configure the settings again.

"3. Initial Settings (NPN/PNP Selection)" (page 2)

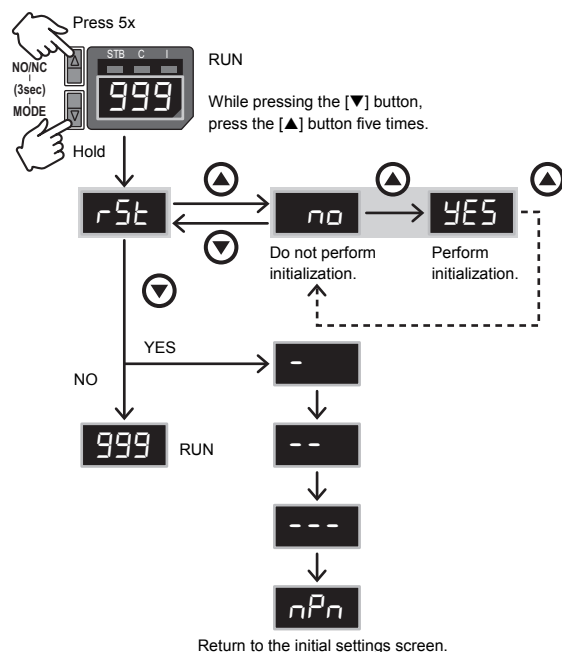

# 8. Settings

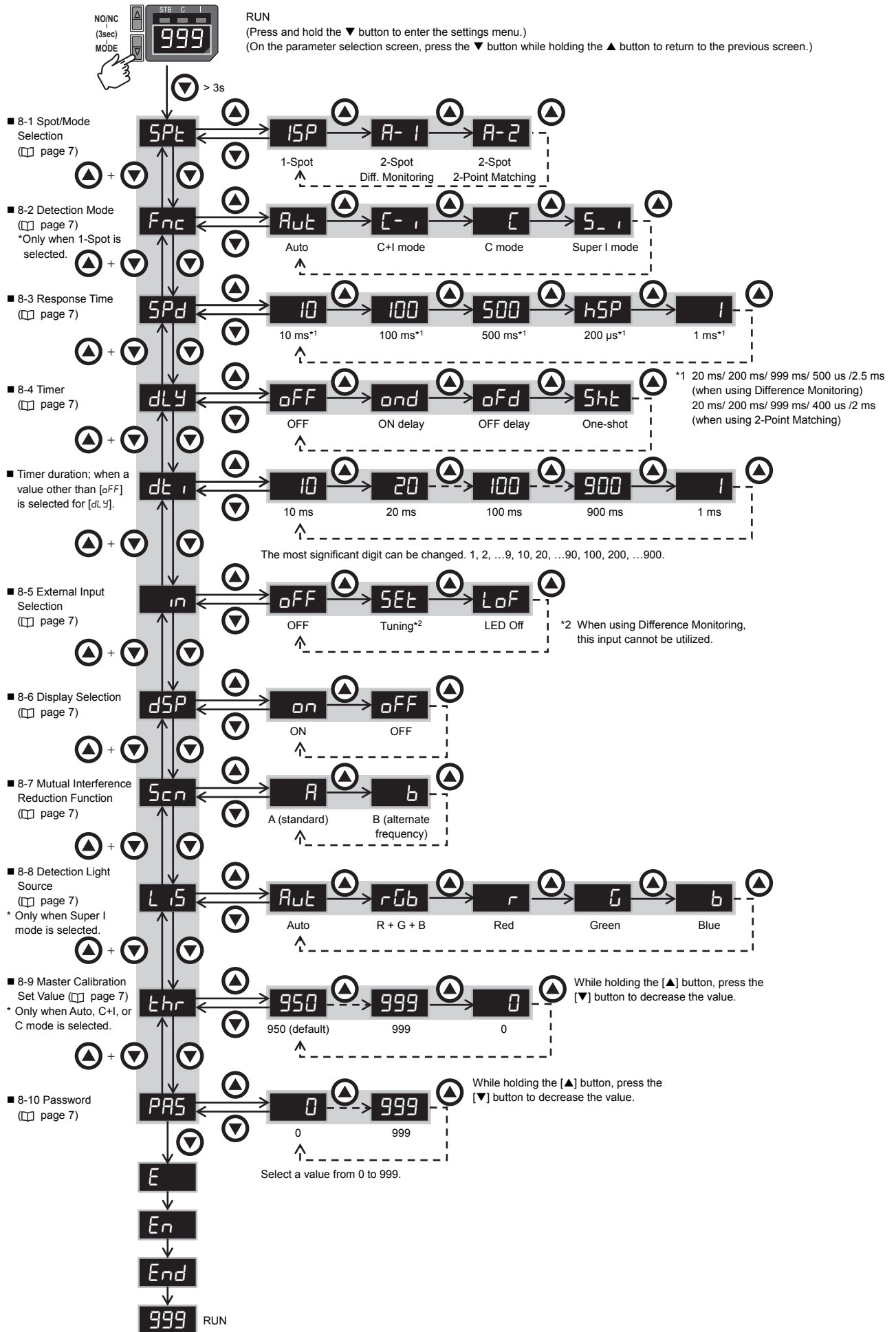

## 8-1 Spot/Mode Selection

Select the number of spots and associated detection mode.

☐ See "4-3 Spot/Mode Selection" (page 2).

## 8-2 Detection Mode

Select the desired detection mode.

☐ See "4-2 Detection Mode" (page 2).

## 8-3 Response Time

The longer the response time, the more reliable and stable the detection.  
When detection is unstable due to the workpieces moving at a high speed, set the response time to a smaller value.

## 8-4 Timer

This function can be used to delay the timing of the sensor output switching.

- ON delay [OND]
- OFF delay [OFFd]
- One-shot [5ht]

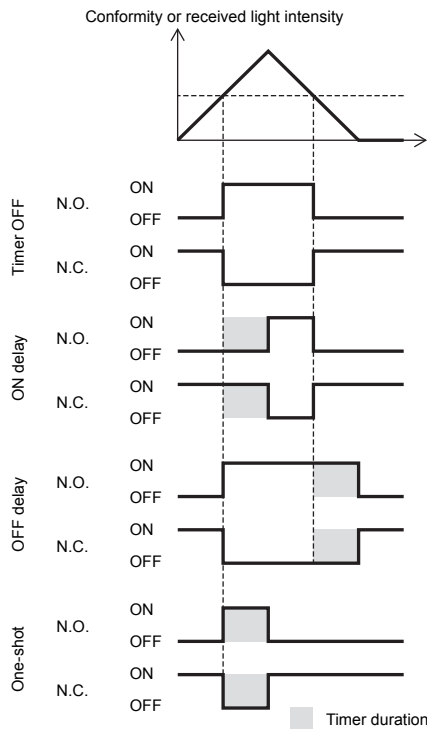

## 8-5 External Input Selection

### ■ Calibration [SEt]

This external input performs the same function as pressing the [SET] button.

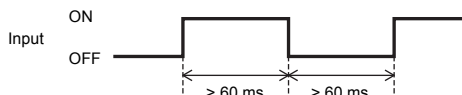

### ■ Transmission OFF [LoF]

This external input stops the emission of the LED.

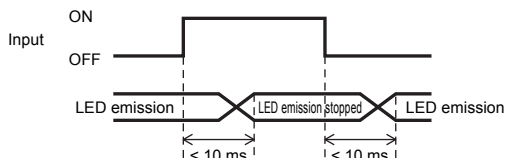

## 8-6 Display Selection

The display can be turned off by selecting [OFF].

## 8-7 Mutual Interference Reduction Function

The effect of mutual interference can be reduced by changing the light emission period. When using multiple LR-W Series units in close proximity, set each unit to a different light emission period. When selecting frequency [B (alternate frequency)], the response time becomes approximately 20% slower.

## 8-8 Detection Light Source

When using [Super I mode], the light source used for detection is automatically selected to provide optimal performance. To require the sensor to use a specific light source, adjust this setting to [Red], [Green], [Blue], or [R + G + B].

## 8-9 Master Calibration Set Value

When using [Auto/C+I/C modes], a predetermined set value is used when master calibration is executed. The predetermined set value can be changed using this menu. When a larger setting value is used, the detection tolerance is tighter. In contrast, when the setting value is reduced, a wider detection tolerance is enabled.

With a higher setting value, there is a higher possibility of saturation or "---" occurring after Master calibration. If Master calibration results in "---", perform Master calibration again after lowering this value.

## 8-10 Password

An optional password can be set to further prohibit unauthorized releasing of the ☐ "7-1 Key Lock" (page 5). Select a value from "1 to 999" for this setting. If "0" is selected, the password will not be required.

## 9. Troubleshooting

### 9-1 Error Display

Display	Cause	Solution
E-rE	Excessive current (overcurrent) is flowing through the output wire.	<ul style="list-style-type: none"> <li>• Check if the output wires are connected correctly and are not in contact with other wires.</li> <li>• Check if the load is within the rated range for the output.</li> </ul>
E-rE	The memory has reached its end of life, or the sensor is malfunctioning.	Perform initialization. If the problem persists, contact KEYENCE.
uuu	Displayed when excessive light is received by the sensor (Auto/C+I/C modes)	Adjust the sensor's installation angle so that specular reflections do not enter the receiver.
nnn	Displayed when insufficient light is received by the sensor (Auto/C+I/C modes)	Check whether the detection distance is within specified range.
Loc	The key lock function is enabled.	Release the key lock. (☐ page 5)
- (The bar pulses across the display.)	The display selection is set to OFF.	Set the display selection to ON. (☐ page 6)

## 9-2 Output When an Error Occurs

Display	Output Condition		Indicator Condition	
	N.O.	N.C.	N.O.	N.C.
ErC	OFF	OFF	Flashing in red	
ErE	Normal operation		Flashing in red	
uuu	OFF	ON	Off	Orange
nnn	OFF	ON	Off	Orange
Loc	Normal operation		Normal operation	
- (The bar pulses across the display.)	Normal operation		Normal operation	

## 9-3 Default Settings/Values List

Item	Initial value
NPN/PNP selection	NPN
N.O./N.C. selection	N.O.
Detection mode	Auto
Response time	10 ms
Timer	OFF
Timer duration	10 ms
External input	OFF
Display selection	ON
Mutual Interference Reduction Function	A (standard)
Detection light source	Auto
Master calibration setting value	950

## 9-4 Other Precautions

- When using the luster canceling attachment (LR-WA2) With some glossy targets (ex. stretched films), stable detection may not be achievable at certain angles. In such cases, rotate the sensor  $\pm 45^\circ$ , as shown in the diagram below, to determine the most appropriate angle for stable detection.

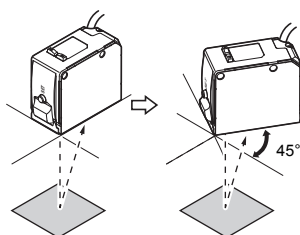

## 9-5 WARRANTIES AND DISCLAIMERS

- KEYENCE warrants the Products to be free of defects in materials and workmanship for a period of one (1) year from the date of shipment. If any models or samples were shown to Buyer, such models or samples were used merely to illustrate the general type and quality of the Products and not to represent that the Products would necessarily conform to said models or samples. Any Products found to be defective must be shipped to KEYENCE with all shipping costs paid by Buyer or offered to KEYENCE for inspection and examination. Upon examination by KEYENCE, KEYENCE, at its sole option, will refund the purchase price of, or repair or replace at no charge any Products found to be defective. This warranty does not apply to any defects resulting from any action of Buyer, including but not limited to improper installation, improper interfacing, improper repair, unauthorized modification, misapplication and mishandling, such as exposure to excessive current, heat, coldness, moisture, vibration or outdoors air. Components which wear are not warranted.
- KEYENCE is pleased to offer suggestions on the use of its various Products. They are only suggestions, and it is Buyer's responsibility to ascertain the fitness of the Products for Buyer's intended use. KEYENCE will not be responsible for any damages that may result from the use of the Products.
- The Products and any samples ("Products/Samples") supplied to Buyer are not to be used internally in humans, for human transportation, as safety devices or fail-safe systems, unless their written specifications state otherwise. Should any Products/Samples be used in such a manner or misused in any way, KEYENCE assumes no responsibility, and additionally Buyer will indemnify KEYENCE and hold KEYENCE harmless from any liability or damage whatsoever arising out of any misuse of the Products/Samples.
- OTHER THAN AS STATED HEREIN, THE PRODUCTS/SAMPLES ARE PROVIDED WITH NO OTHER WARRANTIES WHATSOEVER. ALL EXPRESS, IMPLIED, AND STATUTORY WARRANTIES, INCLUDING, WITHOUT LIMITATION, THE WARRANTIES OF MERCHANTABILITY, FITNESS FOR A PARTICULAR PURPOSE, AND NON-INFRINGEMENT OF PROPRIETARY RIGHTS, ARE EXPRESSLY DISCLAIMED. IN NO EVENT SHALL KEYENCE AND ITS AFFILIATED ENTITIES BE LIABLE TO ANY PERSON OR ENTITY FOR ANY DIRECT, INDIRECT, INCIDENTAL, PUNITIVE, SPECIAL OR CONSEQUENTIAL DAMAGES (INCLUDING, WITHOUT LIMITATION, ANY DAMAGES RESULTING FROM LOSS OF USE, BUSINESS INTERRUPTION, LOSS OF INFORMATION, LOSS OR INACCURACY OF DATA, LOSS OF PROFITS, LOSS OF SAVINGS, THE COST OF PROCUREMENT OF SUBSTITUTED GOODS, SERVICES OR TECHNOLOGIES, OR FOR ANY MATTER ARISING OUT OF OR IN CONNECTION WITH THE USE OR INABILITY TO USE THE PRODUCTS, EVEN IF KEYENCE OR ONE OF ITS AFFILIATED ENTITIES WAS ADVISED OF A POSSIBLE THIRD PARTY'S CLAIM FOR DAMAGES OR ANY OTHER CLAIM AGAINST BUYER.** In some jurisdictions, some of the foregoing warranty disclaimers or damage limitations may not apply.

### BUYER'S TRANSFER OBLIGATIONS:

If the Products/Samples purchased by Buyer are to be resold or delivered to a third party, Buyer must provide such third party with a copy of this document, all specifications, manuals, catalogs, leaflets and written information provided to Buyer pertaining to the Products/Samples.

E 1101-3

## KEYENCE CORPORATION

1-3-14, Higashi-Nakajima, Higashi-Yodogawa-ku,  
Osaka, 533-8555, Japan  
PHONE: +81-6-6379-2211

[www.keyence.com](http://www.keyence.com)

<b>AUSTRIA</b> Ph: +43 22 36-3782 66-0	<b>HONG KONG</b> Ph: +852-3104-1010	<b>NETHERLANDS</b> Ph: +31 40 20 66 100	<b>THAILAND</b> Ph: +66-2-369-2777
<b>BELGIUM</b> Ph: +32 1 528 1222	<b>HUNGARY</b> Ph: +36 1 802 73 60	<b>POLAND</b> Ph: +48 71 36861 60	<b>UK &amp; IRELAND</b> Ph: +44-1908-696900
<b>BRAZIL</b> Ph: +55-11-3045-4011	<b>INDIA</b> Ph: +91-44-4963-0900	<b>ROMANIA</b> Ph: +40 269-232-808	<b>USA</b> Ph: +1-201-930-0100
<b>CANADA</b> Ph: +1-905-366-7655	<b>INDONESIA</b> Ph: +62-21-2966-0120	<b>SINGAPORE</b> Ph: +65-6392-1011	<b>VIETNAM</b> Ph: +84-4-3772-5555
<b>CHINA</b> Ph: +86-21-3357-1001	<b>ITALY</b> Ph: +39-02-6688220	<b>SLOVAKIA</b> Ph: +421 2 5939 6461	
<b>CZECH REPUBLIC</b> Ph: +420 222 191 483	<b>KOREA</b> Ph: +82-31-789-4300	<b>SLOVENIA</b> Ph: +386 1-4701-666	
<b>FRANCE</b> Ph: +33 1 56 37 78 00	<b>MALAYSIA</b> Ph: +60-3-7883-2211	<b>SWITZERLAND</b> Ph: +41 43-45577 30	
<b>GERMANY</b> Ph: +49 6102 36 89-0	<b>MEXICO</b> Ph: +52-55-8850-0100	<b>TAIWAN</b> Ph: +886-2-2718-8700	

Specifications are subject to change without notice.

A6WW1-MAN-1115

Copyright (c) 2015 KEYENCE CORPORATION. All rights reserved.  
13827E 1125-1 [96M13827] Printed in Japan

